

## MiniFlex for Copper and Fiber Application Note

### Contents

Contents.....	1
Summary.....	1
1 Mixed Copper and Fiber Equipment.....	2
2 Mixed Copper and Fiber Applications.....	3

### Summary

This document describes some equipment of the MiniFlex and Orion3 product series with mixed copper and fiber connections. They are fully interoperable and can even be mixed with any third party switch.

## 1 Mixed Copper and Fiber Equipment

The MiniFlex and Orion3 product series have beside the main SHDSL connections the possibility for Fiber connections.

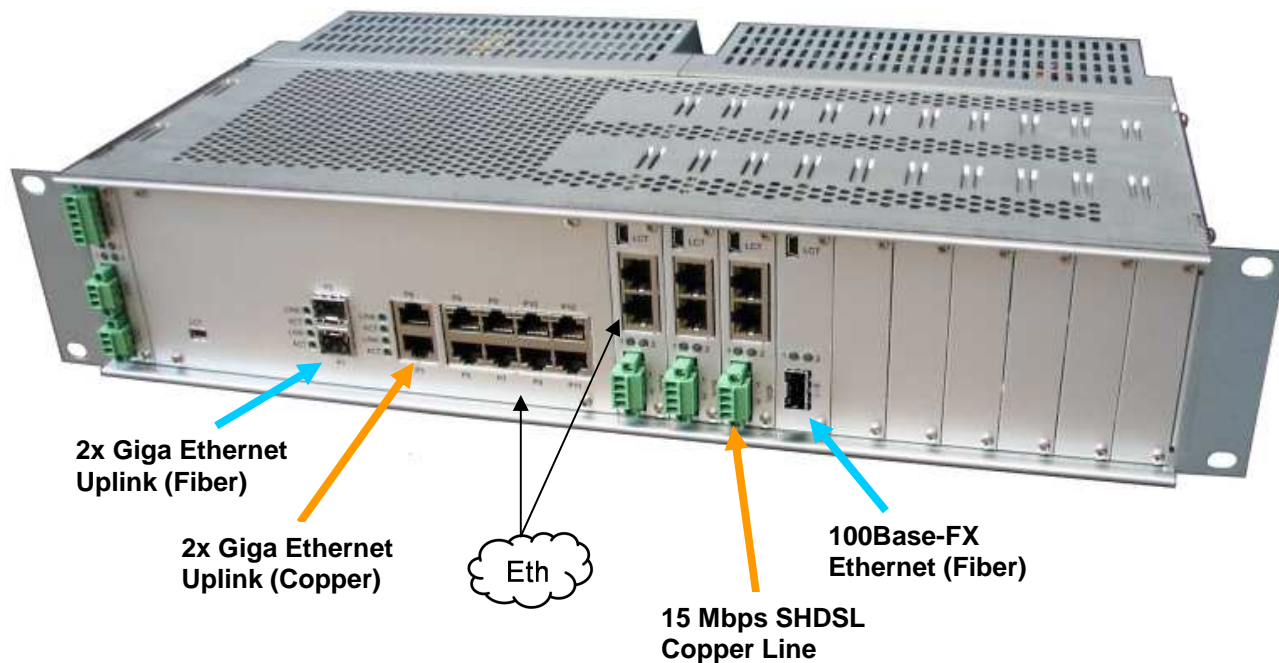

Picture 1.1: MiniFlex 19" 2U Minirack with Fiber & Copper Connections

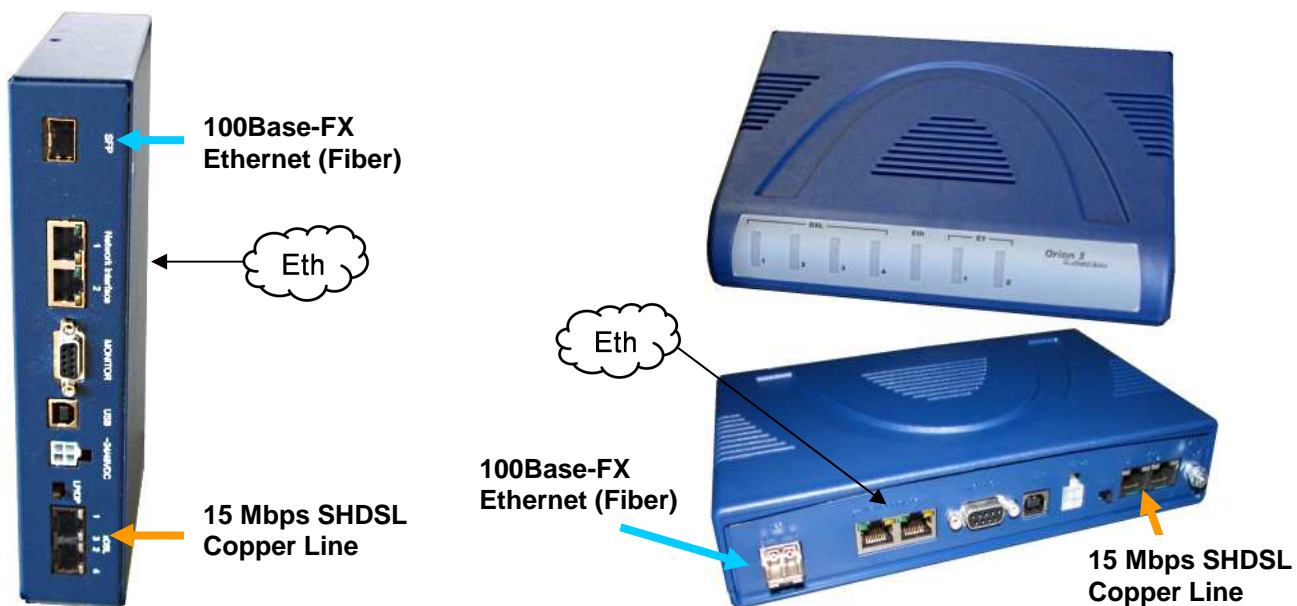

Picture 1.2: Orion3 (V84S) Dinrail Unit with Copper and Fiber Connection

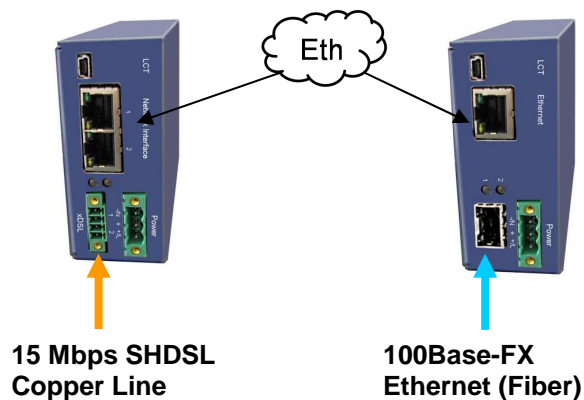

Picture 1.3: MiniFlex Dinrail Units with Copper or Fiber Connection

## 2 Mixed Copper and Fiber Applications

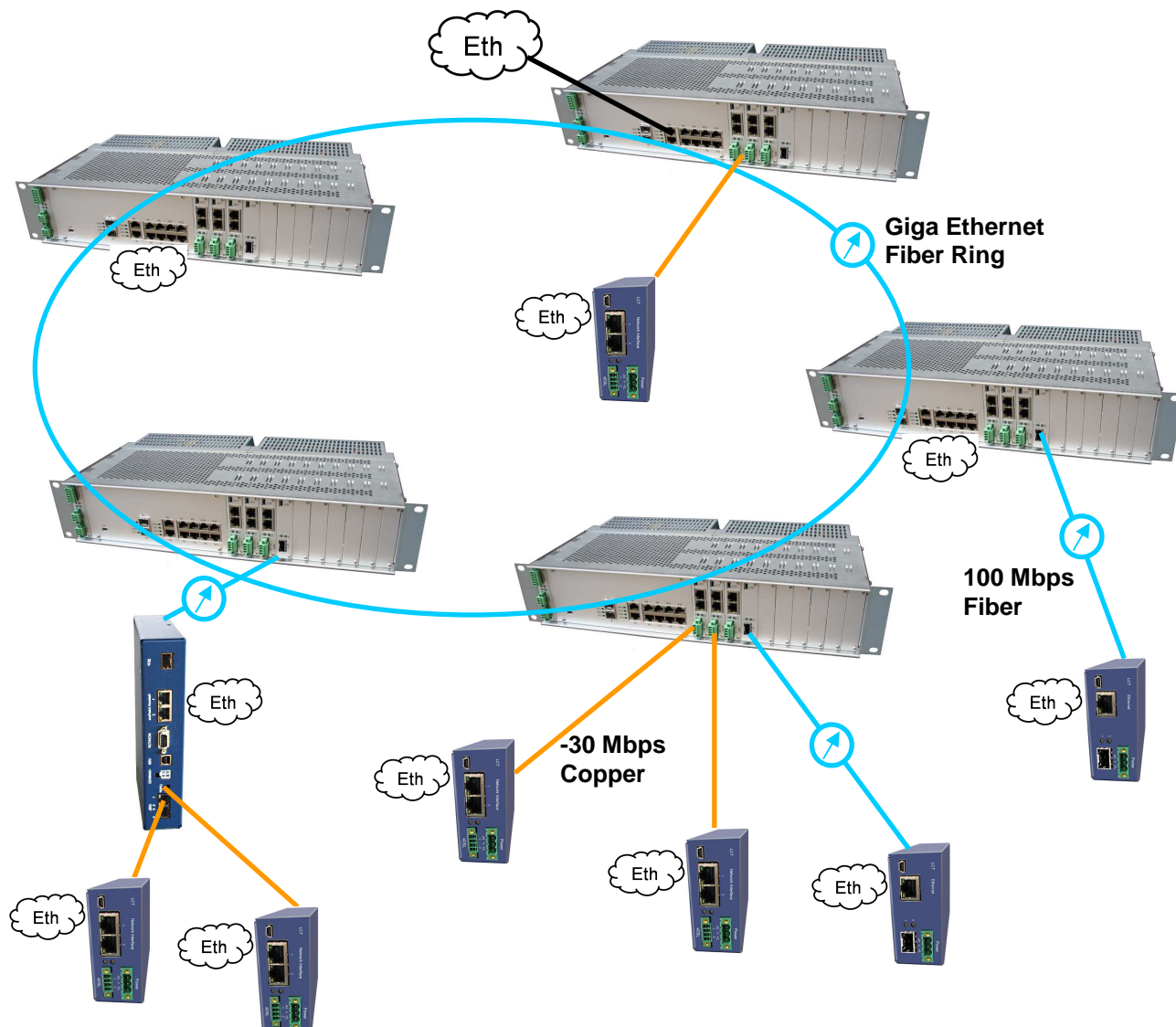

Application 2.1. Giga Fiber Ring and on each Station Fiber or Copper Connections

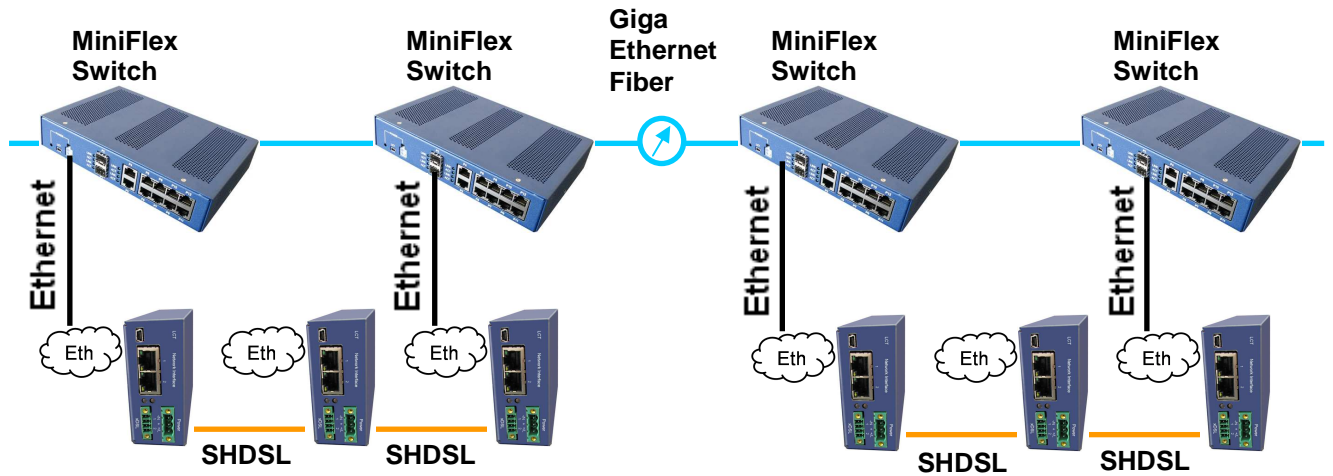

**Application 2.2. Giga Fiber Bus and Ethernet Drop Insert in Ring Networks**

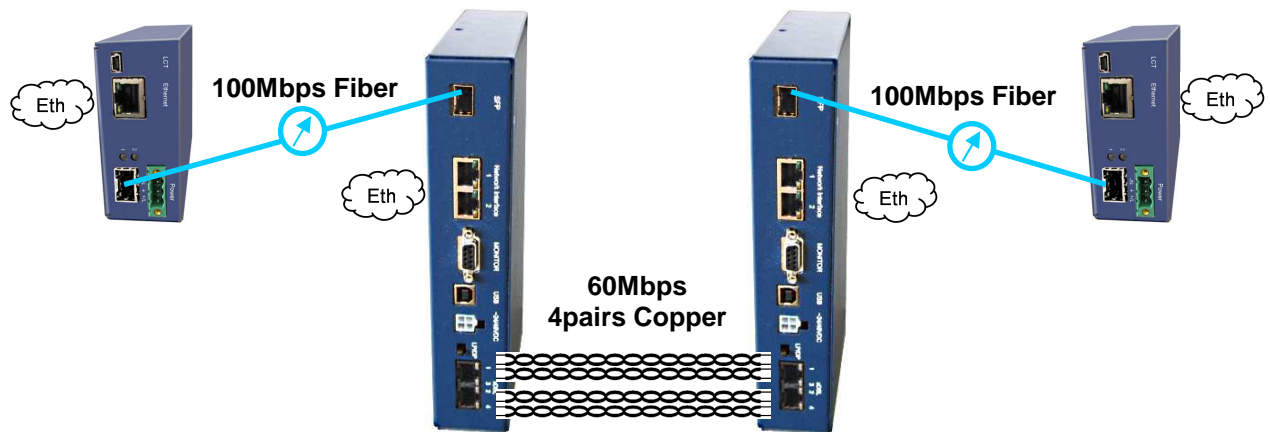

**Application 2.3. 100Mbps Long Distance Copper to Fiber Converter**

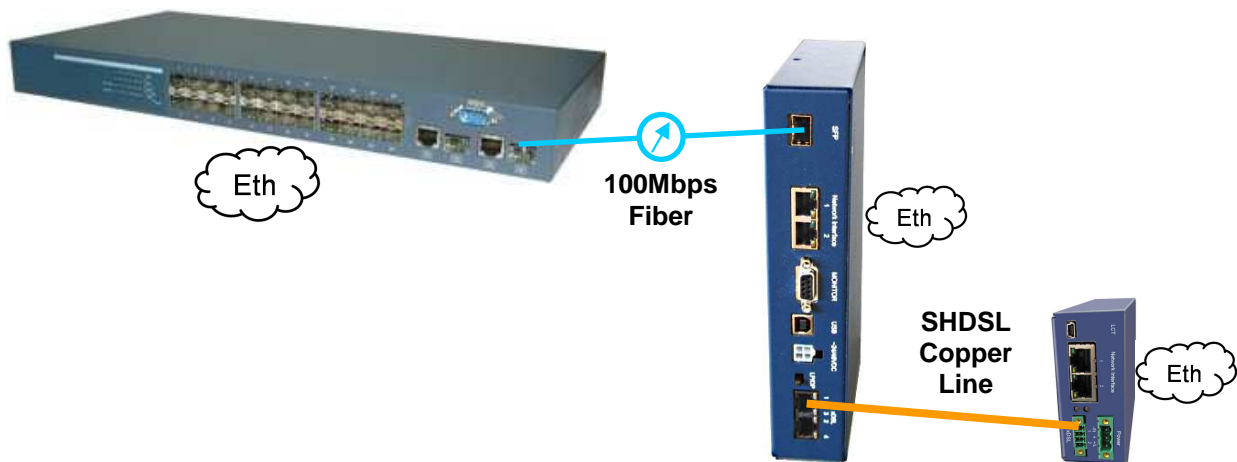

**Application 2.4. Thrid Party Switch Connected to Orion3 or MiniFlex with 100Mbps**